

MILLER DOUBLE

Design Gianfranco Frigerio

Struttura: legno multistrato imbottito in poliuretano espanso indeformabile rivestito in tessuto protettivo accoppiato.

Cuscini seduta: poliuretano espanso indeformabile.

Piano seduta trapuntato: accoppiato a fibra sintetica.

Cuscini schienale: piuma d'oca (Assopiuma).

Piedini: neri.

Rivestimento: sfoderabile in tessuto, fisso in pelle. Rivestimento trapuntato sfoderabile e lavabile esclusivamente a secco.

Profilo: esclusivamente sul cuscino seduta, nello stesso materiale e colore del rivestimento.

ACCESSORI:

| **volumi pouf:** collezione di volumi pouf in differenti misure con rivestimento trapuntato.

| **cuscini decorativi:** cuscini decorativi in dimensioni specifiche in piuma d'oca e la possibilità di aggiungere un elemento poggiatesta.

VERSIONE MILLER DOUBLE TOP: struttura con top imbottito e schienale sporgente, che servono da appoggio e contenimento per accessori

ACCESSORI MILLER TOP:

| Bracciolo CABINET

| Bracciolo VOLUME SOFT

| Bracciolo VOLUME PAD

Varianti: combinale con gli altri elementi della collezione Miller.

VERSIONE MILLER DOUBLE OPEN: struttura con schienale sporgente, che serve da contenimento accessori posizionati a terra.

ACCESSORI MILLER OPEN:

| Bracciolo WOOD

| Bracciolo DAY LOW

Varianti: combinale con gli altri elementi della collezione Miller.

Structure: plywood padded with non-deformable polyurethane foam covered with doubled protective fabric.

Seat cushion: non-deformable polyurethane foam.

Quilted top seat cover: doubled with synthetic fibre layer.

Back cushions: goose down (Assopiuma).

Feet: black.

Cover: removable in fabric, fix in leather. Quilted covers removable, dry clean only.

Piping: on seat cushion only, in the same material and colour as the cover.

ACCESSORIES:

| **volume pouf:** collection of volume poufs in different sizes with quilted cover.

| **beauty cushions:** cushions in specific sizes in goose down and possibility to add a headrest element.

VERSION MILLER DOUBLE TOP: structure with top and longer back suitable for supporting and containing accessories.

ACCESSORIES MILLER TOP:

| Armrest CABINET

| Armrest VOLUME SOFT

| Armrest VOLUME PAD

Variants: to be combined with the other elements of the Miller Collection.

VERSION MILLER DOUBLE OPEN: structure with longer back suitable for containing elements resting on floor.

ACCESSORIES MILLER OPEN:

| Armrest WOOD

| Armrest DAY LOW

Variants: to be combined with the other elements of the Miller Collection.



MILLER DOUBLE FULL BACK

Design Gianfranco Frigerio



ELEMENTI CENTRALI / CENTRAL ELEMENTS

cod. 17000

Elemento 100 cm / Element 100 cm

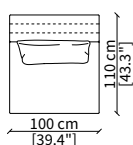
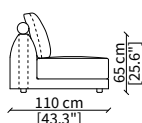
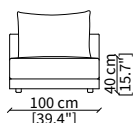

cod. 17001

Elemento 120 cm / Element 120 cm

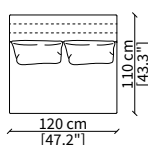
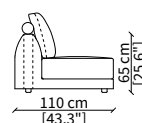
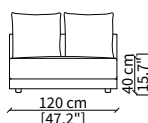

cod. 17005

Elemento 140 cm / Element 140 cm

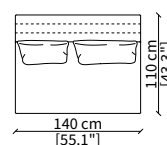
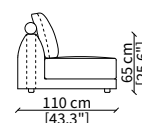
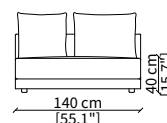

ELEMENTI CHAISE LONGUE / CHAISE LONGUE ELEMENTS

cod. 17002

Elemento 100 cm / Element 100 cm

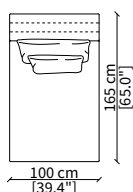
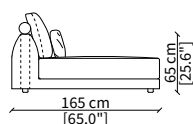
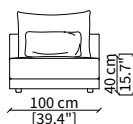

cod. 17003

Elemento 120 cm / Element 120 cm

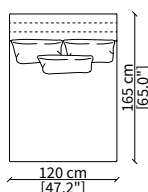
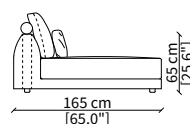
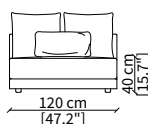

ELEMENTO LONGUE / LONGUE ELEMENT

cod. 17004

Elemento 100 cm / Element 100 cm

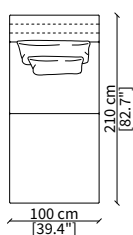
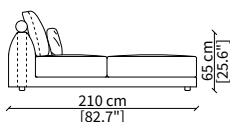
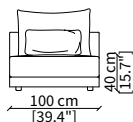

Dimensioni espresse in cm se non diversamente indicato.
L'Azienda si riserva il diritto di apportare modifiche ai modelli senza preavviso.
Tolleranza sulle misure indicate di +/- 2%.

Dimensions in centimeter if not differently indicated.
The Company reserves the right to change the models without any advance notice.
Tolerance on the given sizes +/- 2%.

MILLER DOUBLE FULL BACK

Design Gianfranco Frigerio

ELEMENTI TERMINALI TOP / TERMINAL TOP ELEMENTS

cod. 16800

Terminale 140 cm / Terminal 140 cm

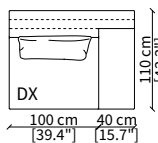
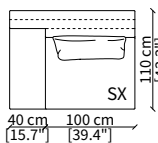
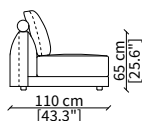
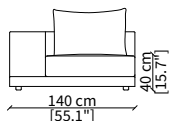

cod. 16803

Terminale 160 cm / Terminal 160 cm

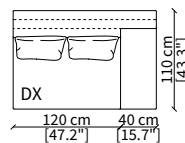
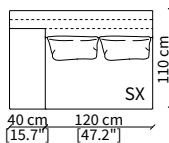
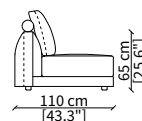
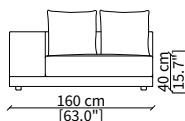

ELEMENTI TERMINALI OPEN / TERMINAL OPEN ELEMENTS

cod. 16900

Terminale 140 cm / Terminal 140 cm

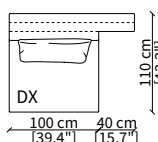
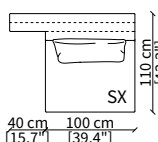
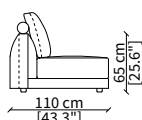
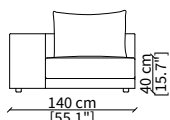

cod. 16903

Terminale 160 cm / Terminal 160 cm

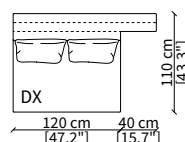
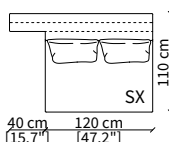
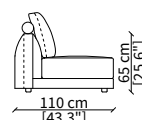
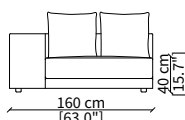

ELEMENTI CHAISE LONGUE TOP / CHAISE LONGUE TOP ELEMENTS

cod. 16806

Elemento 140 cm / Element 140 cm

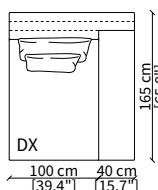
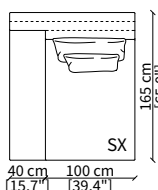
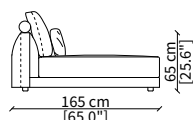
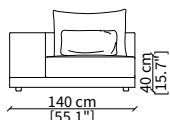

cod. 16809

Elemento 160 cm / Element 160 cm

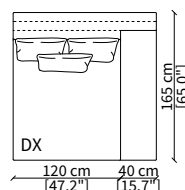
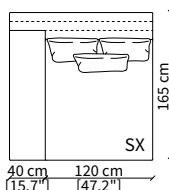
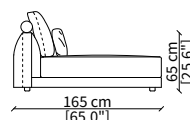
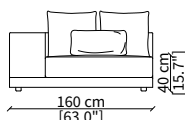

ELEMENTI CHAISE LONGUE OPEN / CHAISE LONGUE OPEN ELEMENTS

cod. 16906

Elemento 140 cm / Element 140 cm

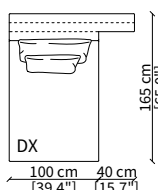
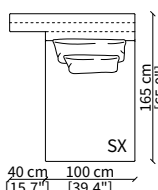
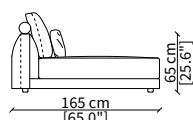
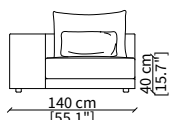

cod. 16909

Elemento 160 cm / Element 160 cm

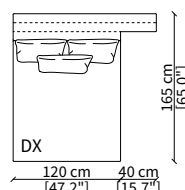
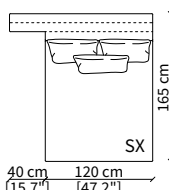
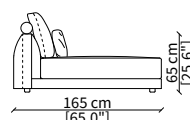
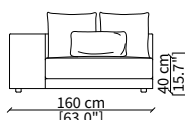

Dimensioni espresse in cm se non diversamente indicato.
L'Azienda si riserva il diritto di apportare modifiche ai modelli senza preavviso.
Tolleranza sulle misure indicate di +/- 2%.

Dimensions in centimeter if not differently indicated.
The Company reserves the right to change the models without any advance notice.
Tolerance on the given sizes +/- 2%.

MILLER DOUBLE FULL BACK

Design Gianfranco Frigerio

ELEMENTI LONGUE TOP / LONGUE TOP ELEMENTS

cod. 16812

Elemento 140 cm / Element 140 cm

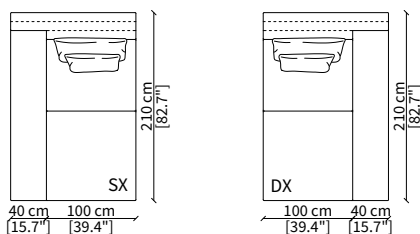
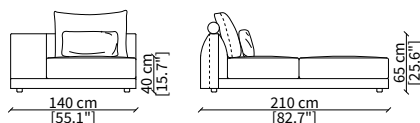

cod. 16815

Elemento 100 cm / Element 100 cm

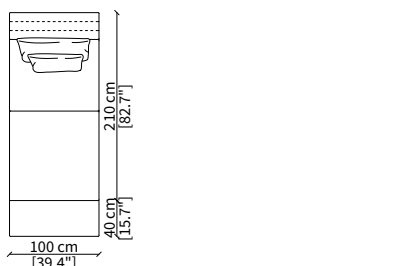
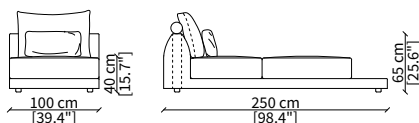

ELEMENTO LONGUE OPEN / LONGUE OPEN ELEMENT

cod. 16912

Elemento 140 cm / Element 140 cm

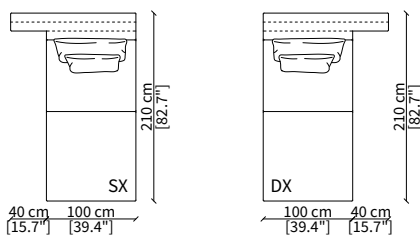
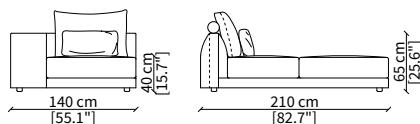

ELEMENTI SEDUTA / SEAT ELEMENTS

cod. 17100

Elemento PLAIN 100 cm / Element PLAIN 100 cm



cod. 17200

Elemento QUILT 100 cm / Element QUILT 100 cm



cod. 17101

Elemento PLAIN 120 cm / Element PLAIN 120 cm

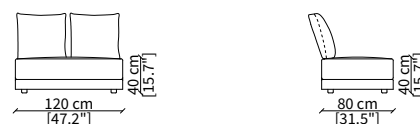

Dimensioni espresse in cm se non diversamente indicato.
L'Azienda si riserva il diritto di apportare modifiche ai modelli senza preavviso.
Tolleranza sulle misure indicate di +/- 2%.

Dimensions in centimeter if not differently indicated.
The Company reserves the right to change the models without any advance notice.
Tolerance on the given sizes +/- 2%.

MILLER DOUBLE FULL BACK

Design Gianfranco Frigerio

cod. 17201

Elemento QUILT 120 cm / Element QUILT 120 cm

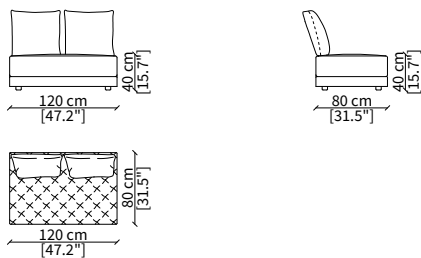

cod. 17102

Elemento PLAIN 140 cm / Element PLAIN 140 cm

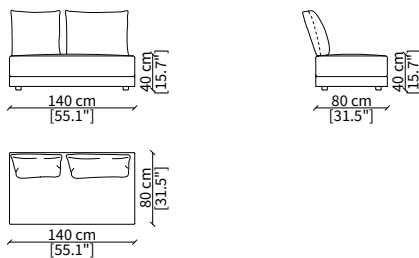

cod. 17202

Elemento QUILT 140 cm / Element QUILT 140 cm

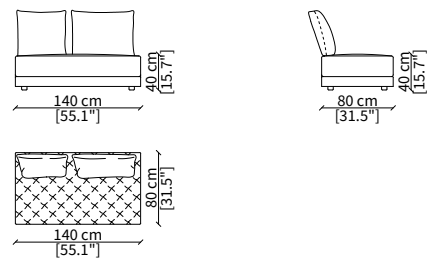

cod. 17103

Elemento PLAIN 160 cm / Element PLAIN 160 cm

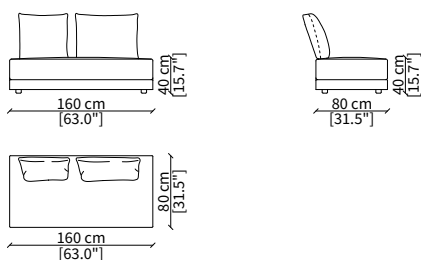

cod. 17203

Elemento QUILT 160 cm / Element QUILT 160 cm

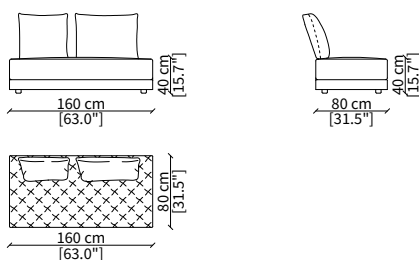

cod. 17104

Elemento PLAIN 100 cm / Element PLAIN 100 cm

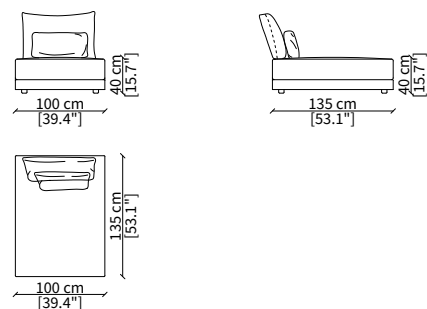

cod. 17204

Elemento QUILT 100 cm / Element QUILT 100 cm

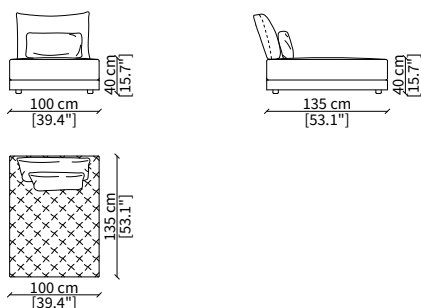

cod. 17105

Elemento PLAIN 120 cm / Element PLAIN 120 cm

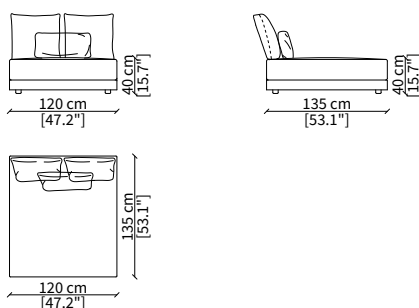

cod. 17205

Elemento QUILT 120 cm / Element QUILT 120 cm

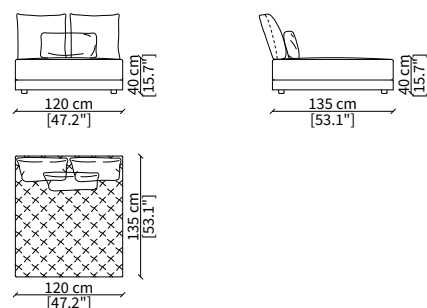

VOLUME SOFT

cod. 15532

Elemento QUILT 88 cm / Element QUILT 88 cm



cod. 15533

Elemento QUILT 100 cm / Element QUILT 100 cm



cod. 15534

Elemento QUILT 143 cm / Element QUILT 143 cm

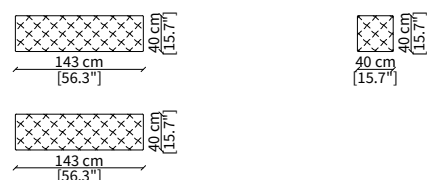

Dimensioni espresse in cm se non diversamente indicato.
L'Azienda si riserva il diritto di apportare modifiche ai modelli senza preavviso.
Tolleranza sulle misure indicate di +/- 2%.

Dimensions in centimeter if not differently indicated.
The Company reserves the right to change the models without any advance notice.
Tolerance on the given sizes +/- 2%.

MILLER DOUBLE FULL BACK

Design Gianfranco Frigerio

VOLUME PAD

cod. 15535

Elemento 88 cm / Element 88 cm



cod. 15536

Elemento 100 cm / Element 100 cm

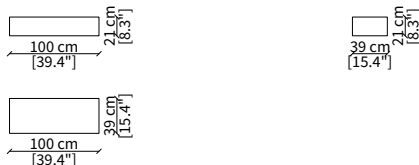

cod. 15537

Elemento 143 cm / Element 143 cm

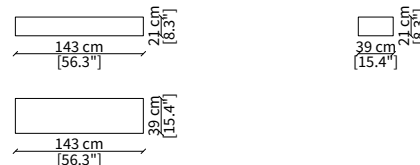

CABINET

cod. 15541

Elemento 88 cm / Element 88 cm



cod. 15542

Elemento 100 cm / Element 100 cm



cod. 15543

Elemento 143 cm / Element 143 cm

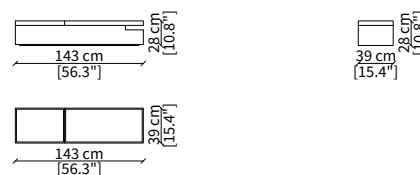

BRACCIOLI / ARMRESTS

cod. 15526

Bracciolo DAY LOW 88 cm / Armrest DAY LOW 88 cm

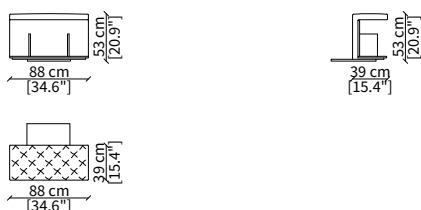

cod. 15527

Bracciolo DAY LOW 100 cm / Armrest DAY LOW 100 cm

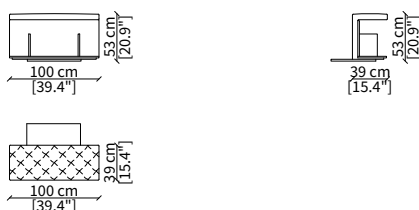

cod. 15528

Bracciolo DAY LOW 143 cm / Armrest DAY LOW 143 cm

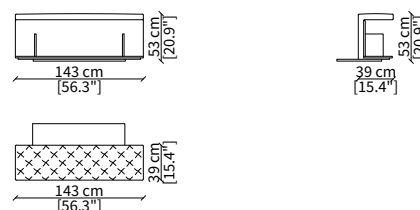

cod. 15538

Bracciolo WOOD 88 cm / Armrest WOOD 88 cm

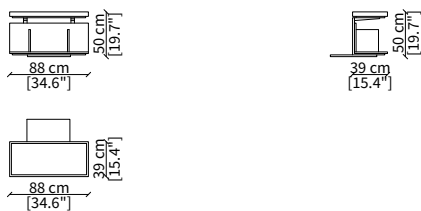

cod. 15539

Bracciolo WOOD 100 cm / Armrest WOOD 100 cm

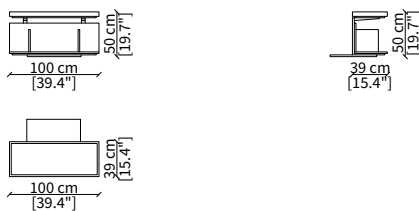

cod. 15540

Bracciolo WOOD 143 cm / Armrest WOOD 143 cm

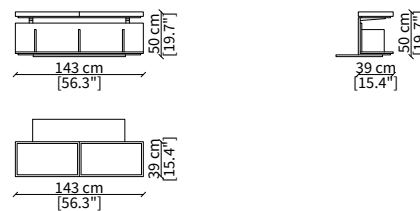

POUFS

cod. 17121

Elemento 155x40 cm / Element 155x40 cm

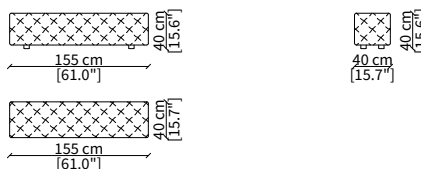

cod. 17122

Elemento 190x40 cm / Element 190x40 cm

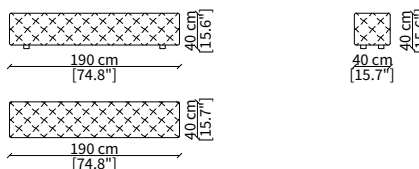

Dimensioni espresse in cm se non diversamente indicato.
L'Azienda si riserva il diritto di apportare modifiche ai modelli senza preavviso.
Tolleranza sulle misure indicate di +/- 2%.

Dimensions in centimeter if not differently indicated.
The Company reserves the right to change the models without any advance notice.
Tolerance on the given sizes +/- 2%.

MILLER DOUBLE FULL BACK

Design Gianfranco Frigerio

CUSCINI / CUSHIONS

cod. AM

Cuscino 63x28 cm / Cushion 63x28 cm

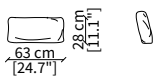

cod. PM

Cuscino 55x53 cm / Cushion 55x53 cm

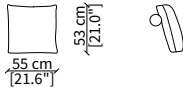

cod. MM

Cuscino 70x53 cm / Cushion 70x53 cm

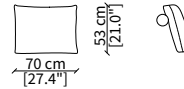

cod. GM

Cuscino 80x53 cm / Cushion 80x53 cm

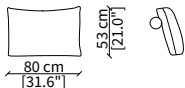

cod. PMD

Cuscino 55x53 cm / Cushion 55x53 cm

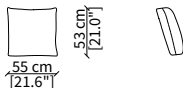

cod. MMD

Cuscino 70x53 cm / Cushion 70x53 cm

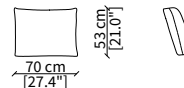

cod. GMD

Cuscino 80x53 cm / Cushion 80x53 cm

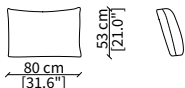

cod. 10424

Cuscino a libero posizionamento 57x53 cm
Freestanding backrest 57x53 cm

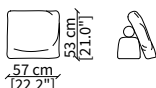

cod. 10425

Cuscino a libero posizionamento 78x53 cm
Freestanding backrest 78x53 cm

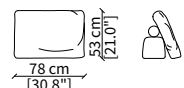

cod. 15448

Cuscino poggiatesta 60x73,5 cm
Headrest cushion 60x73,5 cm

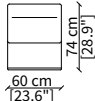

MILLER DOUBLE SHAPED BACK

Design Gianfranco Frigerio



ELEMENTI TERMINALI TOP / TERMINAL TOP ELEMENTS

cod. 16801

Terminale 140 cm / Terminal 140 cm

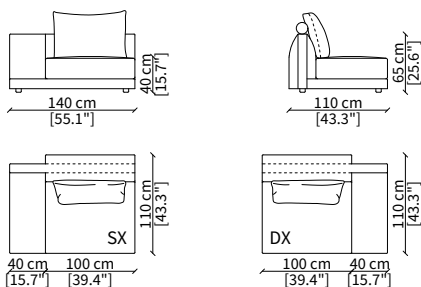

cod. 16802

Terminale 140 cm / Terminal 140 cm

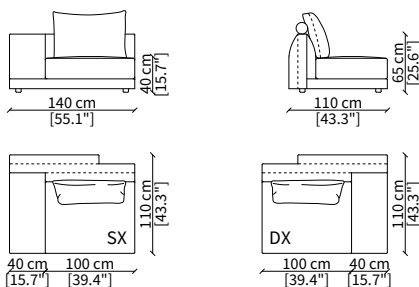

cod. 16804

Terminale 160 cm / Terminal 160 cm

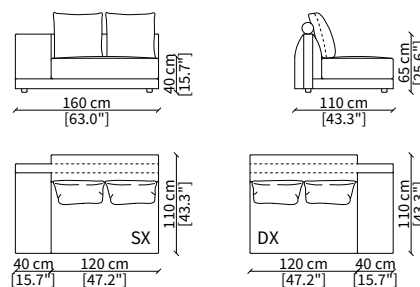

cod. 16805

Terminale 160 cm / Terminal 160 cm

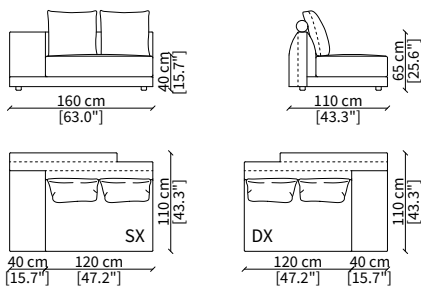

Dimensioni espresse in cm se non diversamente indicato.
L'Azienda si riserva il diritto di apportare modifiche ai modelli senza preavviso.
Tolleranza sulle misure indicate di +/- 2%.

Dimensions in centimeter if not differently indicated.
The Company reserves the right to change the models without any advance notice.
Tolerance on the given sizes +/- 2%.

MILLER DOUBLE SHAPED BACK Design Gianfranco Frigerio

ELEMENTI TERMINALI OPEN / TERMINAL OPEN ELEMENTS

cod. 16901

Terminale 140 cm / Terminal 140 cm

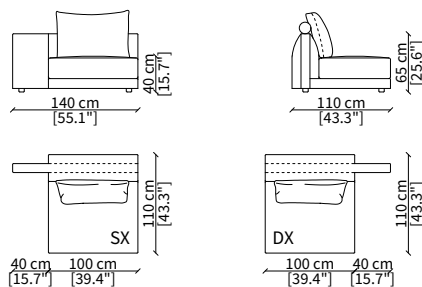

cod. 16902

Terminale 140 cm / Terminal 140 cm

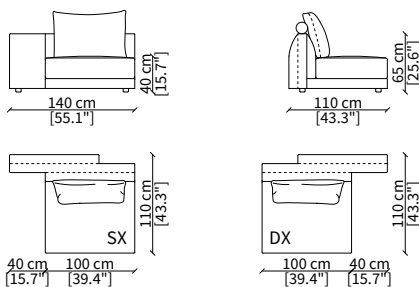

cod. 16904

Terminale 160 cm / Terminal 160 cm

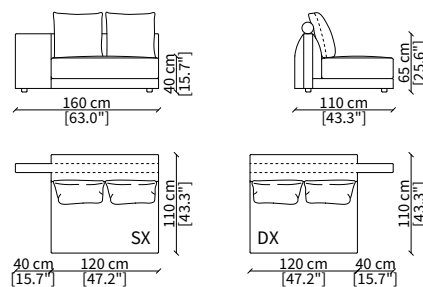

cod. 16905

Terminale 160 cm / Terminal 160 cm

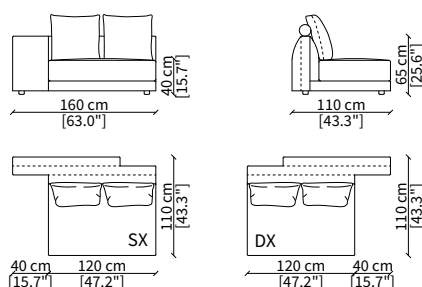

ELEMENTI CHAISE LONGUE TOP / CHAISE LONGUE TOP ELEMENTS

cod. 16807

Elemento 140 cm / Element 140 cm

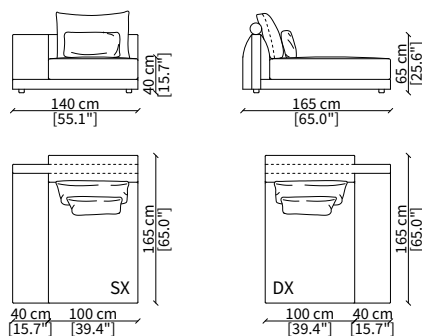

cod. 16808

Elemento 140 cm / Element 140 cm

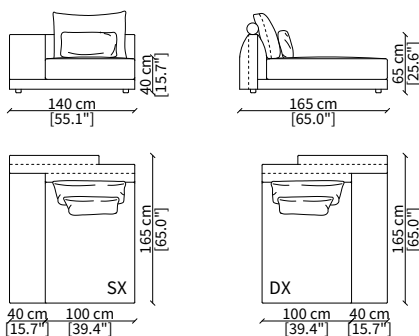

cod. 16810

Elemento 160 cm / Element 160 cm

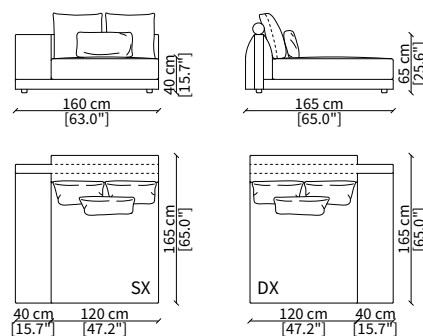

cod. 16811

Elemento 160 cm / Element 160 cm

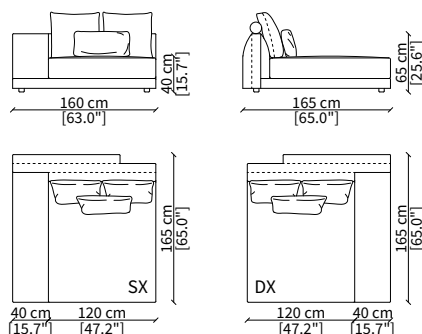

Dimensioni espresse in cm se non diversamente indicato.
L'Azienda si riserva il diritto di apportare modifiche ai modelli senza preavviso.
Tolleranza sulle misure indicate di +/- 2%.

Dimensions in centimeter if not differently indicated.
The Company reserves the right to change the models without any advance notice.
Tolerance on the given sizes +/- 2%.

MILLER DOUBLE SHAPED BACK Design Gianfranco Frigerio

ELEMENTI CHAISE LONGUE OPEN / CHAISE LONGUE OPEN ELEMENTS

cod. 16907

Elemento 140 cm / Element 140 cm

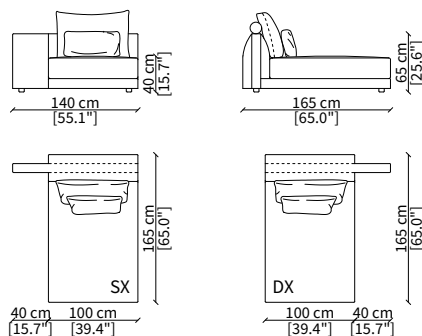

cod. 16908

Elemento 140 cm / Element 140 cm

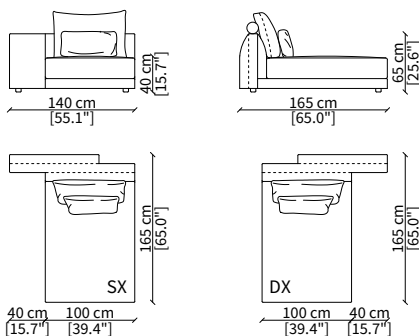

cod. 16910

Elemento 160 cm / Element 160 cm

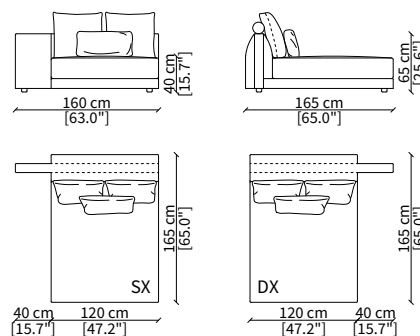

cod. 16911

Elemento 160 cm / Element 160 cm

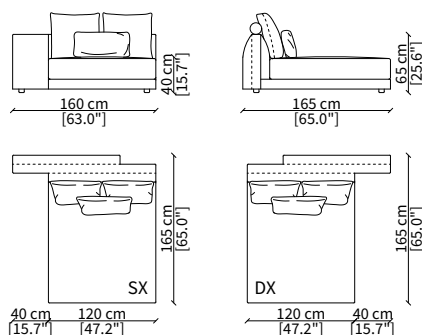

ELEMENTI LONGUE TOP / LONGUE TOP ELEMENTS

cod. 16813

Elemento 140 cm / Element 140 cm

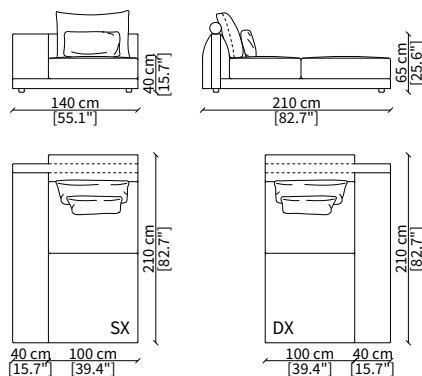

cod. 16814

Elemento 140 cm / Element 140 cm

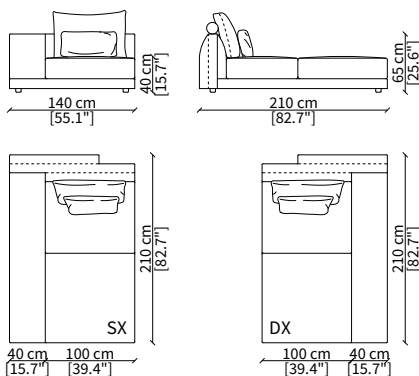

Dimensioni espresse in cm se non diversamente indicato.
L'Azienda si riserva il diritto di apportare modifiche ai modelli senza preavviso.
Tolleranza sulle misure indicate di +/- 2%.

Dimensions in centimeter if not differently indicated.
The Company reserves the right to change the models without any advance notice.
Tolerance on the given sizes +/- 2%.

MILLER DOUBLE SHAPED BACK Design Gianfranco Frigerio

ELEMENTI LONGUE OPEN / LONGUE OPEN ELEMENTS

cod. 16913

Elemento 140 cm / Element 140 cm

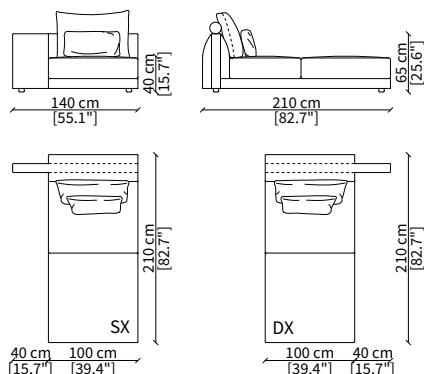

cod. 16914

Elemento 140 cm / Element 140 cm

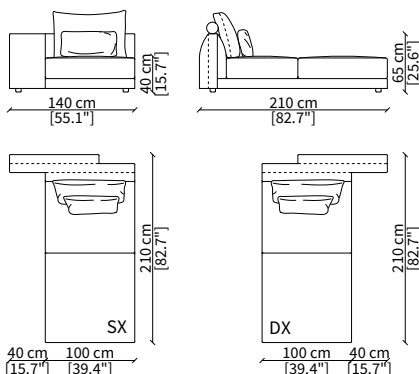

ELEMENTI SEDUTA TOP / SEAT TOP ELEMENTS

cod. 17110

Elemento PLAIN 140 cm / Element PLAIN 140 cm

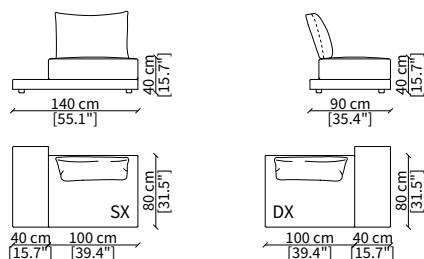

cod. 17210

Elemento QUILT 140 cm / Element QUILT 140 cm

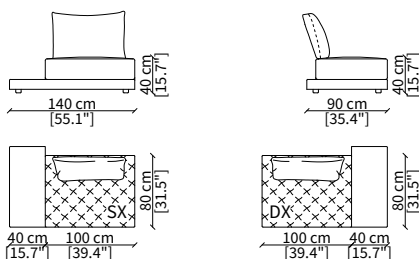

cod. 17111

Elemento PLAIN 160 cm / Element PLAIN 160 cm

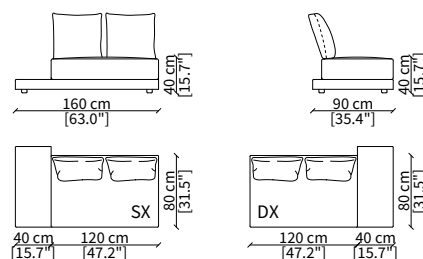

cod. 17211

Elemento QUILT 160 cm / Element QUILT 160 cm

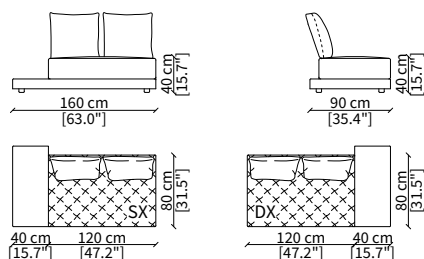

cod. 17112

Elemento PLAIN 140 cm / Element PLAIN 140 cm

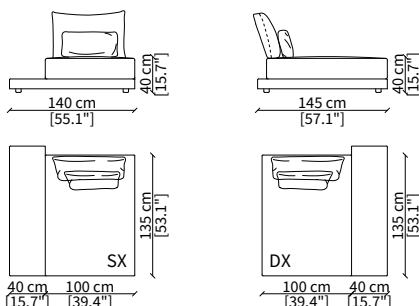

cod. 17212

Elemento QUILT 140 cm / Element QUILT 140 cm

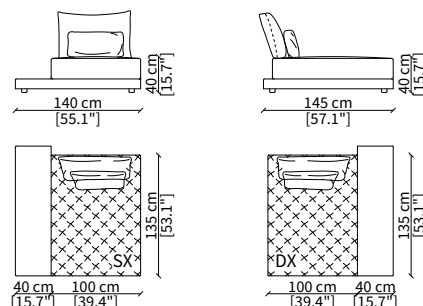

Dimensioni espresse in cm se non diversamente indicato.
L'Azienda si riserva il diritto di apportare modifiche ai modelli senza preavviso.
Tolleranza sulle misure indicate di +/- 2%.

Dimensions in centimeter if not differently indicated.
The Company reserves the right to change the models without any advance notice.
Tolerance on the given sizes +/- 2%.

MILLER DOUBLE SHAPED BACK Design Gianfranco Frigerio

cod. 17113

Elemento PLAIN 160 cm / Element PLAIN 160 cm

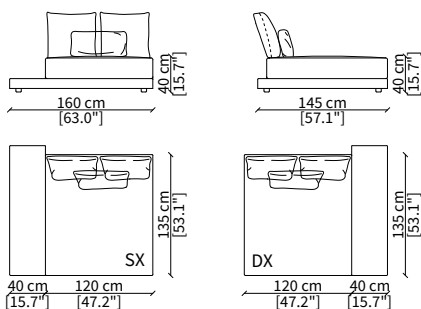

cod. 17213

Elemento QUILT 160 cm / Element QUILT 160 cm

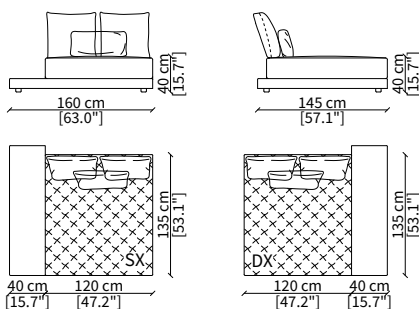

ELEMENTI SEDUTA / SEAT ELEMENTS

cod. 17100

Elemento PLAIN 100 cm / Element PLAIN 100 cm

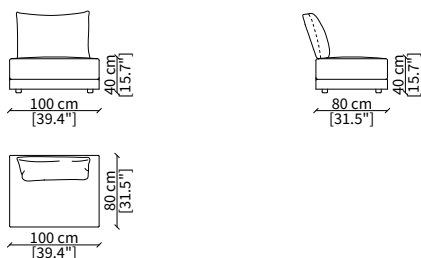

cod. 17200

Elemento QUILT 100 cm / Element QUILT 100 cm

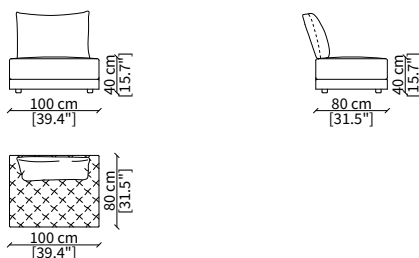

cod. 17101

Elemento PLAIN 120 cm / Element PLAIN 120 cm

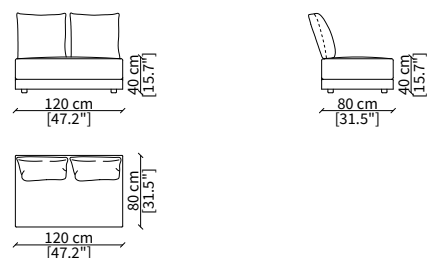

cod. 17201

Elemento QUILT 120 cm / Element QUILT 120 cm

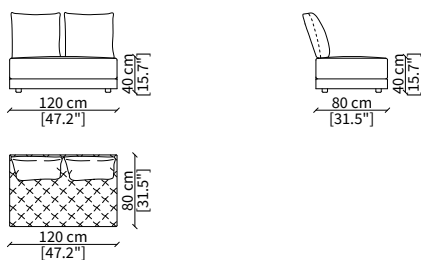

cod. 17102

Elemento PLAIN 140 cm / Element PLAIN 140 cm

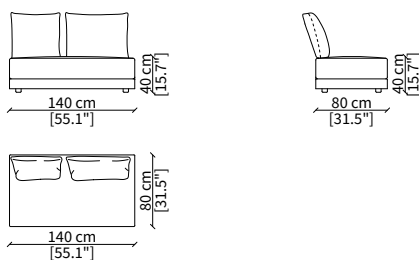

cod. 17202

Elemento QUILT 140 cm / Element QUILT 140 cm

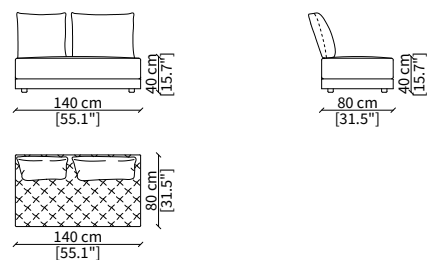

cod. 17103

Elemento PLAIN 160 cm / Element PLAIN 160 cm

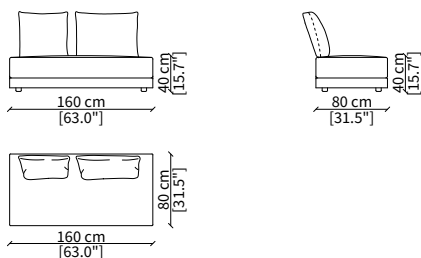

cod. 17203

Elemento QUILT 160 cm / Element QUILT 160 cm

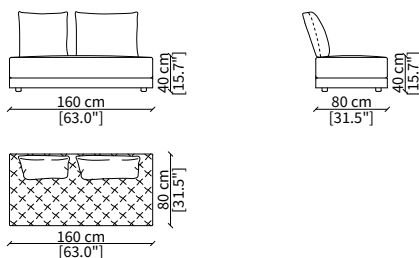

cod. 17104

Elemento PLAIN 100 cm / Element PLAIN 100 cm

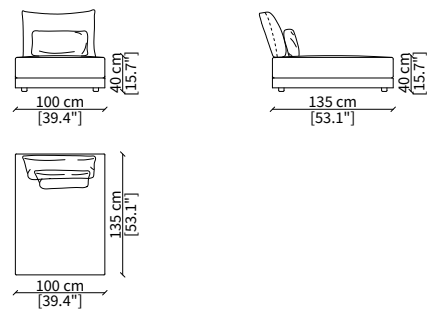

Dimensioni espresse in cm se non diversamente indicato.
L'Azienda si riserva il diritto di apportare modifiche ai modelli senza preavviso.
Tolleranza sulle misure indicate di +/- 2%.

Dimensions in centimeter if not differently indicated.
The Company reserves the right to change the models without any advance notice.
Tolerance on the given sizes +/- 2%.

MILLER DOUBLE SHAPED BACK

Design Gianfranco Frigerio

cod. 17204

Elemento QUILT 100 cm / Element QUILT 100 cm

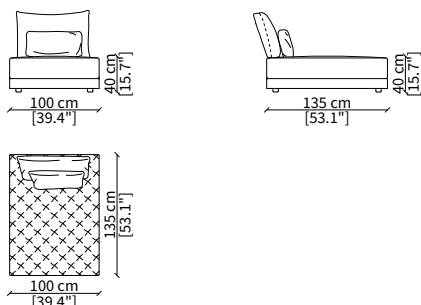

cod. 17105

Elemento PLAIN 120 cm / Element PLAIN 120 cm

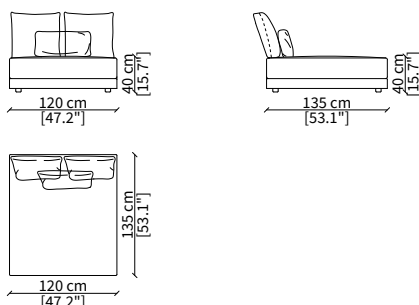

cod. 17205

Elemento QUILT 120 cm / Element QUILT 120 cm

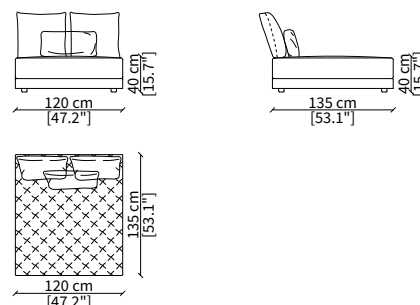

VOLUME SOFT

cod. 15532

Elemento QUILT 88 cm / Element QUILT 88 cm

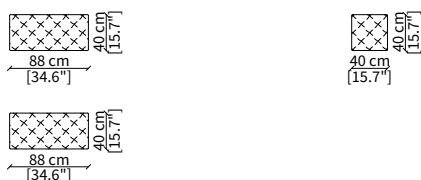

cod. 15533

Elemento QUILT 100 cm / Element QUILT 100 cm



cod. 15534

Elemento QUILT 143 cm / Element QUILT 143 cm

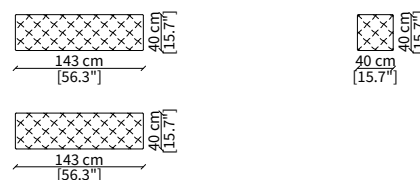

VOLUME PAD

cod. 15535

Elemento 88 cm / Element 88 cm



cod. 15536

Elemento 100 cm / Element 100 cm

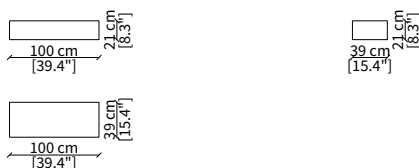

cod. 15537

Elemento 143 cm / Element 143 cm

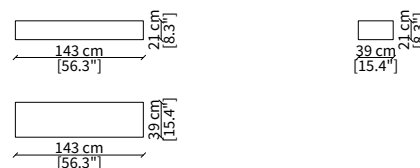

CABINET

cod. 15541

Elemento 88 cm / Element 88 cm



cod. 15542

Elemento 100 cm / Element 100 cm



cod. 15543

Elemento 143 cm / Element 143 cm

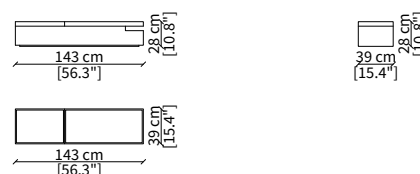

BRACCIOLI / ARMRESTS

cod. 15526

Bracciolo DAY LOW 88 cm / Armrest DAY LOW 88 cm

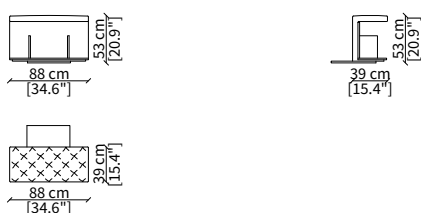

cod. 15527

Bracciolo DAY LOW 100 cm / Armrest DAY LOW 100 cm

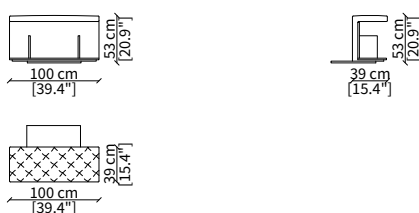

cod. 15528

Bracciolo DAY LOW 143 cm / Armrest DAY LOW 143 cm

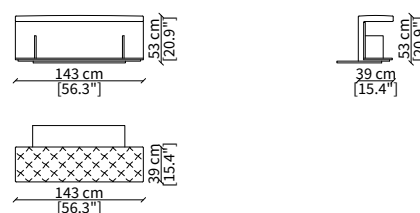

Dimensioni espresse in cm se non diversamente indicato.
L'Azienda si riserva il diritto di apportare modifiche ai modelli senza preavviso.
Tolleranza sulle misure indicate di +/- 2%.

Dimensions in centimeter if not differently indicated.
The Company reserves the right to change the models without any advance notice.
Tolerance on the given sizes +/- 2%.

MILLER DOUBLE SHAPED BACK Design Gianfranco Frigerio

cod. 15538

Bracciolo WOOD 88 cm / Armrest WOOD 88 cm

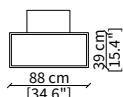
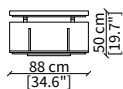

cod. 15539

Bracciolo WOOD 100 cm / Armrest WOOD 100 cm

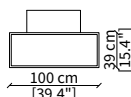
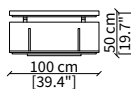

cod. 15540

Bracciolo WOOD 143 cm / Armrest WOOD 143 cm

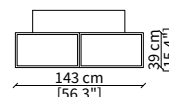
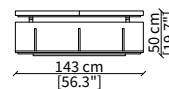

POUFS

cod. 17121

Elemento 155x40 cm / Element 155x40 cm

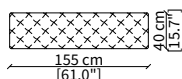
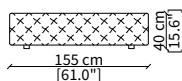

cod. 17122

Elemento 190x40 cm / Element 190x40 cm

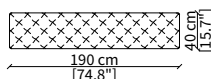
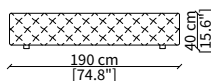

CUSCINI / CUSHIONS

cod. AM

Cuscino 63x28 cm / Cushion 63x28 cm

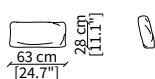

cod. PM

Cuscino 55x53 cm / Cushion 55x53 cm

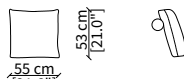

cod. MM

Cuscino 70x53 cm / Cushion 70x53 cm

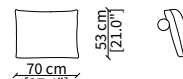

cod. GM

Cuscino 80x53 cm / Cushion 80x53 cm

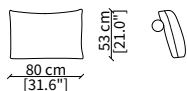

cod. PMD

Cuscino 55x53 cm / Cushion 55x53 cm

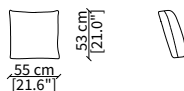

cod. MMD

Cuscino 70x53 cm / Cushion 70x53 cm

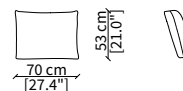

cod. GMD

Cuscino 80x53 cm / Cushion 80x53 cm

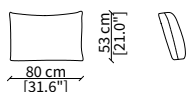

cod. 10424

Cuscino a libero posizionamento 57x53 cm
Freestanding backrest 57x53 cm

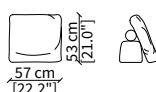

cod. 10425

Cuscino a libero posizionamento 78x53 cm
Freestanding backrest 78x53 cm



cod. 15448

Cuscino poggiatesta 60x73,5 cm
Headrest cushion 60x73,5 cm

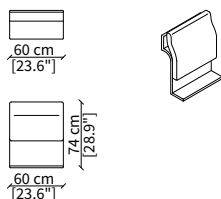

Dimensioni espresse in cm se non diversamente indicato.
L'Azienda si riserva il diritto di apportare modifiche ai modelli senza preavviso.
Tolleranza sulle misure indicate di +/- 2%.

Dimensions in centimeter if not differently indicated.
The Company reserves the right to change the models without any advance notice.
Tolerance on the given sizes +/- 2%.

MILLER DOUBLE TOP

Design Gianfranco Frigerio



Struttura con top imbottito e schienale sporgente, che servono da appoggio e contenimento per i loro accessori, che sono privi di piedini e assicurati al top tramite calamite.

Structure with upholstered top and longer backrest, used to support and contain their accessories, which are without feet and secured to the top by magnets.

VOLUME SOFT



15532

Elemento TOP con volume SOFT. Volume SOFT, elemento imbottito e trapuntato.



15533



15534

Element TOP with volume SOFT. Volume SOFT, padded and quilted element.

VOLUME PAD



15535

Elemento TOP con volume PAD. Volume PAD, elemento disponibile in gres porcellanato effetto marmo, rivestito in cuoio oppure impiallacciato nelle finiture della collezione Frigerio.



15536



15537

Element TOP with volume PAD. Volume PAD, element available in gres porcelain marble effect, in hide leather or veneered in the finishes of the Frigerio collection.

CABINET



15541

Elemento TOP con volume CABINET. Volume CABINET, elemento disponibile in finitura impiallacciata nelle finiture della collezione Frigerio.



15542



15543

Element TOP with volume CABINET. Volume CABINET, element available veneered in the finishes of the Frigerio collection.

MILLER DOUBLE OPEN

Design Gianfranco Frigerio



Struttura con schienale sporgente, che serve da contenimento accessori posizionati a terra.

Structure with longer back suitable for containing elements resting on floor.

DAY LOW



15526

Elemento OPEN bracciolo DAY LOW.

Bracciolo DAY LOW con parte trapuntata in tessuto o pelle e parte libreria in impiallacciato nelle finiture della collezione Frigerio. Basamento in metallo color brunito.



15527



15528

Element OPEN armrest DAY LOW. Armrest DAY LOW with quilted part in fabric or leather and bookcase part veneered in the finishes of the Frigerio collection. Base in metal burnished colour.

WOOD



15526

Elemento OPEN bracciolo WOOD.

Bracciolo WOOD impiallacciato nelle finiture della collezione Frigerio. Basamento in metallo color brunito.



15527



15528

Element OPEN armrest WOOD. Armrest WOOD veneered in the finishes of the Frigerio collection. Base in metal burnished colour.

MILLER DOUBLE

Design Gianfranco Frigerio

ESEMPI DI COMBINAZIONI / COMBINATION EXAMPLES

cod. 15700

divano 180 cm cod. 15700

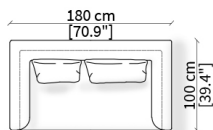

cod. 15715

terminale 120 cm cod. 15715

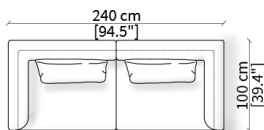

cod. 15718 + 15733

terminale 160 cm cod. 15718
dormeuse angolo 220 cm cod. 15733

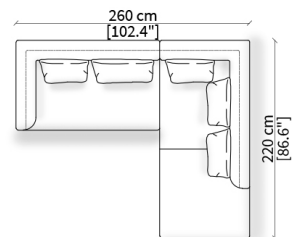

cod. 15718 + 15731

terminale 160 cm cod. 15718
chaise longue angolo 120 cm cod. 15731

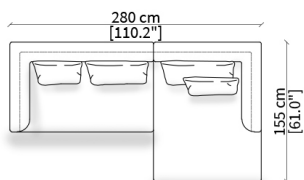

cod. 15715 + 15703 + 15802 + 15822

terminale 120 cm cod. 15715
centrale 100 cm cod. 15703
terminale top 140/100 cm cod. 15802
pouf top 140/100 cm cod. 15822

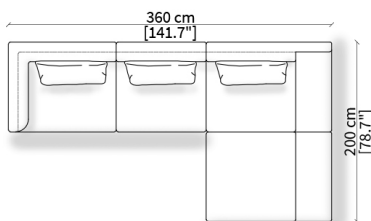

cod. 15715 + 15703 + 15611

terminale 120 cm cod. 15715
centrale 100 cm cod. 15703
dormeuse terminale pouf 260 cm cod. 15611

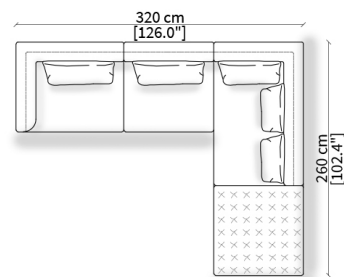

cod. 15800 + 15532 + 15701 + 15825 + 15736

terminale top 120/80 cm cod. 15800
pouf volume 88x40 cm cod. 15532
centrale 80 cm cod. 15701
elemento curvo 142 cm cod. 15825
pouf 100x100 cm cod. 15736

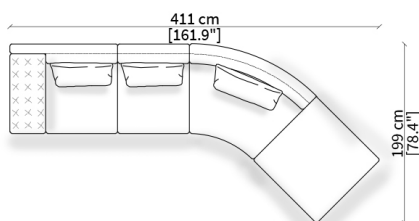

cod. 15436 + 15703 + 15825 + 15814 + 15538

pouf 100x100 cm cod. 15436
centrale 100 cm cod. 15703
elemento curvo 142 cm cod. 15825
terminale open 140/100 cm cod. 15814
wood 88 cm cod. 15538

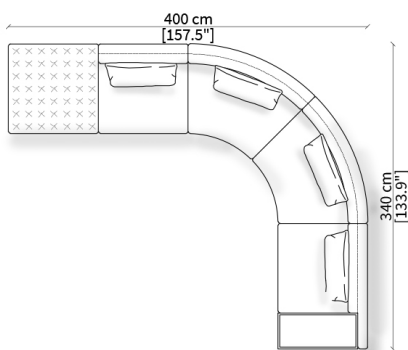

cod. 15817+15526+15522+15703+15814+15538

terminale open 180/140 cm cod. 15817
day low 88 cm cod. 15526
pouf top 140/100 cm cod. 15522
centrale 100 cm cod. 15703
terminale open 140/100 cm cod. 15814
wood 88 cm cod. 15538
pad 100 cm cod. 15536

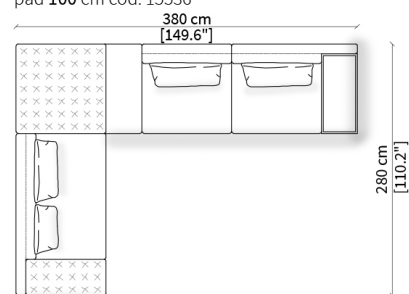

MILLER DOUBLE Design Gianfranco Frigerio

TESSUTO / FABRIC



Asole



Avignone



Bellagio



Butterfly



Caprera



Capri



Caracalla



Chioggia



Candotti



Dorian

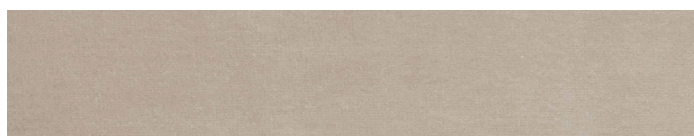

Fiocco



Il Trovatore



Ischia



Katmandu



La Boheme



Lario



Linosa



Maddalena

La presente tabella tessile, pelli e materiali è a solo titolo indicativo e non vincolante. L'effettiva disponibilità di ogni materiale deve essere preventivamente verificata con l'ufficio commerciale Frigerio.

L'azienda si riserva il diritto di sospendere la disponibilità di qualsiasi materiale senza alcun obbligo di preavviso sulla presente scheda tecnica.

I colori visualizzati, per ovvie ragioni tecniche, sono indicativi e possono differire dall'originale. Fare riferimento al listino prezzi per uso e disponibilità di ogni singola finitura.

The above textile, leather and material charts are only indicative and not binding. The actual availability of any material shall be checked in advance with the Frigerio commercial office.

The company reserves the right to discontinue any material without any obligation of due notice on this technical data sheet.

The colours visualized, for obvious technical reasons, are indicative and may differ from the original.

Please refer to price list for use and availability of each finish.

MILLER DOUBLE Design Gianfranco Frigerio

TESSUTO / FABRIC



Moritz



Nebraska

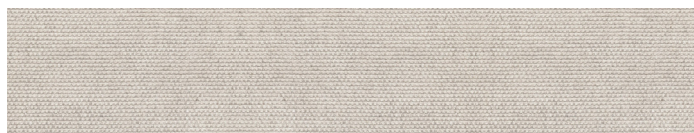

Padova



Panarea



Piazza Di Spagna

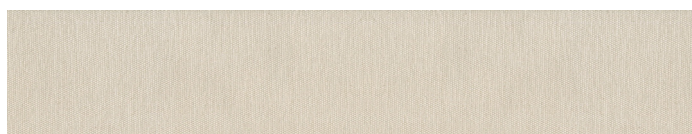

Ponza



Porto Cervo



Porto Rotondo

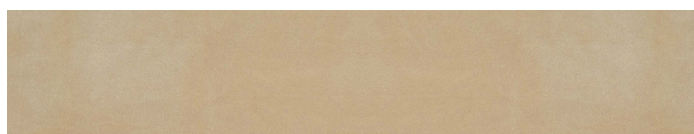

Rem



San Remo

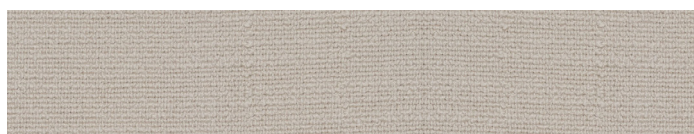

Tellaro



Tenerife

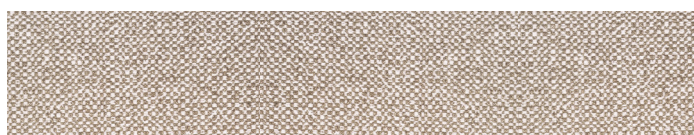

Turandot



Ventotene



Villa Borghese

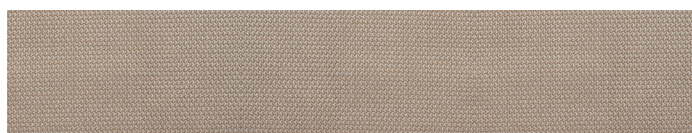

Villa d'Este

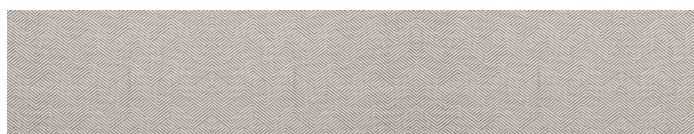

Villa Flori



VF 1650

La presente tabella tessile, pelli e materiali è a solo titolo indicativo e non vincolante. L'effettiva disponibilità di ogni materiale deve essere preventivamente verificata con l'ufficio commerciale Frigerio.

L'azienda si riserva il diritto di sospendere la disponibilità di qualsiasi materiale senza alcun obbligo di preavviso sulla presente scheda tecnica.

I colori visualizzati, per ovvie ragioni tecniche, sono indicativi e possono differire dall'originale. Fare riferimento al listino prezzi per uso e disponibilità di ogni singola finitura.

The above textile, leather and material charts are only indicative and not binding. The actual availability of any material shall be checked in advance with the Frigerio commercial office.

The company reserves the right to discontinue any material without any obligation of due notice on this technical data sheet.

The colours visualized, for obvious technical reasons, are indicative and may differ from the original.

Please refer to price list for use and availability of each finish.

MILLER DOUBLE Design Gianfranco Frigerio

TESSUTO / FABRIC

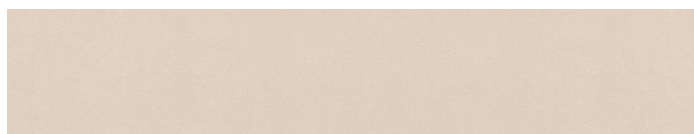

VF 1700



VF 1750



VF 1800

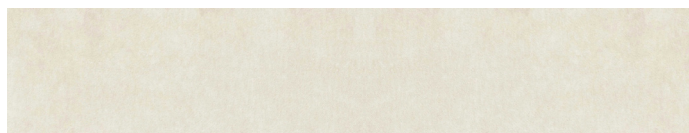

VF 2450



VF 2550

PELLE / LEATHER

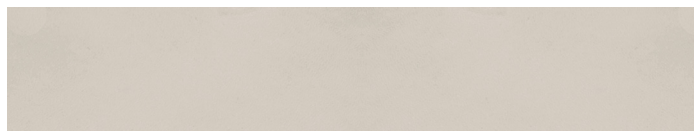

Nubuk

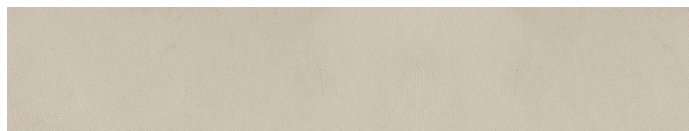

Anilina



Siena



Bolgheri

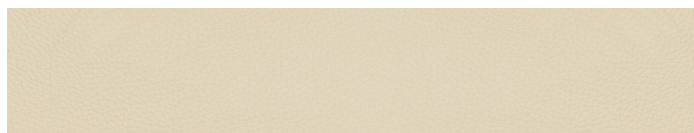

Pisa

La presente tabella tessile, pelli e materiali è a solo titolo indicativo e non vincolante. L'effettiva disponibilità di ogni materiale deve essere preventivamente verificata con l'ufficio commerciale Frigerio.

L'azienda si riserva il diritto di sospendere la disponibilità di qualsiasi materiale senza alcun obbligo di preavviso sulla presente scheda tecnica.

I colori visualizzati, per ovvie ragioni tecniche, sono indicativi e possono differire dall'originale. Fare riferimento al listino prezzi per uso e disponibilità di ogni singola finitura.

The above textile, leather and material charts are only indicative and not binding. The actual availability of any material shall be checked in advance with the Frigerio commercial office.

The company reserves the right to discontinue any material without any obligation of due notice on this technical data sheet.

The colours visualized, for obvious technical reasons, are indicative and may differ from the original.

Please refer to price list for use and availability of each finish.

MILLER DOUBLE Design Gianfranco Frigerio

CUOIO / HIDE LEATHER



COL. 03

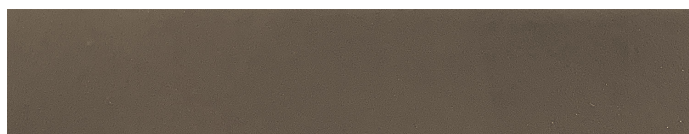

Col. 04

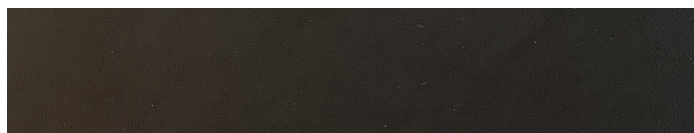

SienaCol. 08

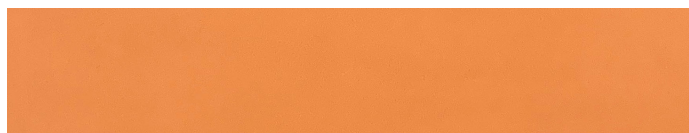

Col. 12

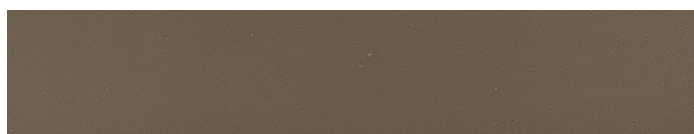

Col. 18



Col. 20

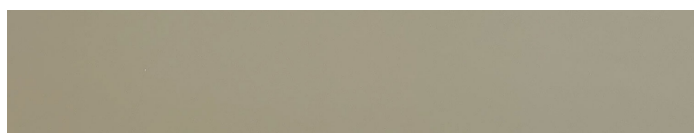

Col. 24

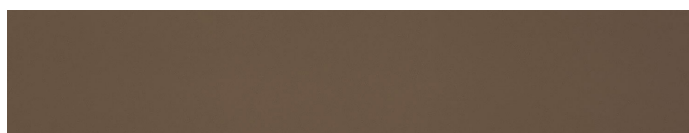

Col. 28



Col. 30

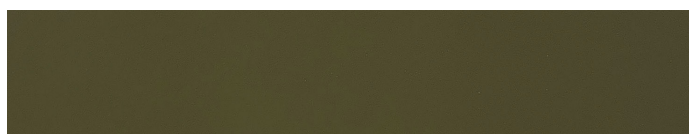

Col. 32

Essenze / Wood



Noce Canaletto
Walnut Canaletto



Frassino Sabbia
Ashwood Sand

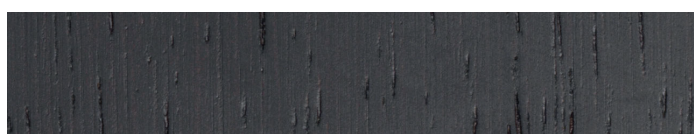

Frassino Wengè
Ashwood Wengè

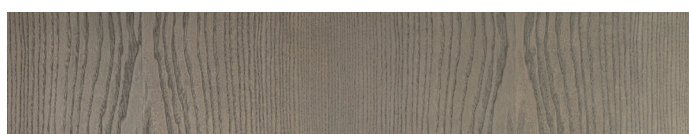

Frassino Greige
Ashwood Greige

La presente tabella tessile, pelli e materiali è a solo titolo indicativo e non vincolante. L'effettiva disponibilità di ogni materiale deve essere preventivamente verificata con l'ufficio commerciale Frigerio.

L'azienda si riserva il diritto di sospendere la disponibilità di qualsiasi materiale senza alcun obbligo di preavviso sulla presente scheda tecnica.

I colori visualizzati, per ovvie ragioni tecniche, sono indicativi e possono differire dall'originale. Fare riferimento al listino prezzi per uso e disponibilità di ogni singola finitura.

The above textile, leather and material charts are only indicative and not binding. The actual availability of any material shall be checked in advance with the Frigerio commercial office.

The company reserves the right to discontinue any material without any obligation of due notice on this technical data sheet.

The colours visualized, for obvious technical reasons, are indicative and may differ from the original.

Please refer to price list for use and availability of each finish.

MILLER DOUBLE

Design Gianfranco Frigerio

TOP

Gres effetto marmo / Porcelain stoneware marble effect



Bright Onyx Lucido
Glossy Bright Onyx



Gold Onyx Lucido
Glossy Gold Onyx



Glam Bronze Lucido
Glossy Glam Bronze

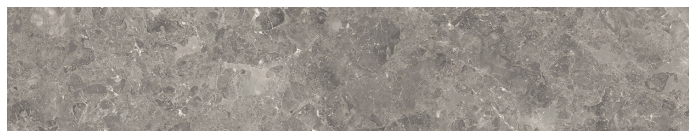

Mineral Grey Opaco
Matt Mineral Grey

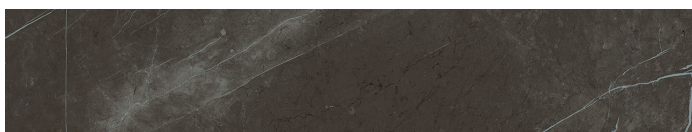

Pietra Grey Lucido
Glossy Pietra Grey

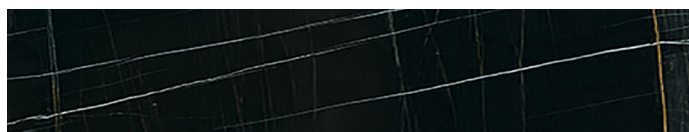

Deep Noir Lucido
Glossy Deep Noir

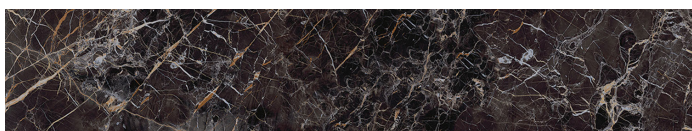

Saint Laurent Lucido
Glossy Saint Laurent

METALLI / METALS

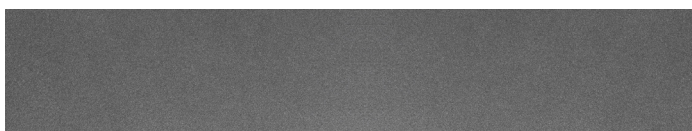

Color Brunito
Burnished Colour

PIEDINI / FEET



Color Nero
Black Colour

PROFILO / PIPING

Per il profilo tono su tono fare riferimento alla gamma tessile Frigerio. Per il profilo in contrasto, disponibile solo in Grosgrain, fare riferimento al listino prezzi e alla pagina del sito dedicata.

For piping tone on tone please refer to the textile range of Frigerio. For piping in contrast, available only in Grosgrain, please refer to the price list and the dedicated landing page in our website.

La presente tabella tessile, pelli e materiali è a solo titolo indicativo e non vincolante. L'effettiva disponibilità di ogni materiale deve essere preventivamente verificata con l'ufficio commerciale Frigerio.

L'azienda si riserva il diritto di sospendere la disponibilità di qualsiasi materiale senza alcun obbligo di preavviso sulla presente scheda tecnica. I colori visualizzati, per ovvie ragioni tecniche, sono indicativi e possono differire dall'originale. Fare riferimento al listino prezzi per uso e disponibilità di ogni singola finitura.

The above textile, leather and material charts are only indicative and not binding. The actual availability of any material shall be checked in advance with the Frigerio commercial office. The company reserves the right to discontinue any material without any obligation of due notice on this technical data sheet.

The colours visualized, for obvious technical reasons, are indicative and may differ from the original. Please refer to price list for use and availability of each finish.